

VOTRONIC

Installation and Operating Manual

Solar Controller SR 140 Duo Digital	12 V / 9.0 A (140 Wp)	No. 1610
Solar Controller SR 220 Duo Digital	12 V / 14.0 A (220 Wp)	No. 1615
Solar Controller SR 330 Duo Digital	12 V / 21.0 A (330 Wp)	No. 1620
Solar Controller SR 530 Duo Digital	12 V / 33.0 A (530 Wp)	No. 1625



Please read the operating manual of the solar controller thoroughly prior to use, connection and start-up.

For campers and caravans.

The solar controller is a special development for use in campers and caravans, and it is suitable for all types and makes of lead batteries (also for acid, GEL/dryfit, AGM/fleece batteries, as well as LiFePO4 batteries). Optimum charging is ensured by an intelligent microprocessor control with characteristic lines IU1oU2.

Working fully automatically and maintenance-free, the solar controller offers the following functions:

Battery Ports and Charging Programs:

Charging port board battery I, depending on the type of battery (lead or LiFePO4), 3 or 5 charging programs selectable (see table 1):

Lead Battery:

- "Liquid Acid/AGM1": Closed and open **acid/lead-acid** batteries, as well as **AGM** with indication **14.4 V**
- „AGM2 “: Closed, gas-tight **AGM/fleece** batteries (absorbed glass Mat, lead-fleece technology) with the indication **14.7 V**.
- „ Gel “: Closed, gas-tight **Gel/dryfit** batteries (determined electrolyte)

LiFePO4 Battery:

- "14.2 V": Lithium iron phosphate batteries with a charging voltage of **14.2 V**.
- "14.4 V": Lithium iron phosphate batteries with a charging voltage of **14.4 V**.
- "14.6 V": Lithium iron phosphate batteries with a charging voltage of **14.6 V**.
- "14.7 V": Lithium iron phosphate batteries with a charging voltage of **14.7 V**.
- "14.8 V": Lithium iron phosphate batteries with a charging voltage of **14.8 V**.

Charging Port Starter Battery II:

Separate auxiliary charging port with reduced charging current (12 V (0.8 A or 1.5 A) for support charging and trickle charging of the vehicle's starter battery with overcharge protection in case of extended stop periods.

Further Characteristics of the Unit:

- The **charging voltage** being **free from peaks** is **controlled** in such a way, that any **overcharging** of the batteries is **excluded**.
- Two Battery Charging Ports:** Automatic charging of the main battery or board battery (Board I): Support charging and trickle charging of the vehicle's starter battery (Start II) with overcharge protection.
- Unattended Charging:** Standard protection against back discharge of battery (in case of insufficient solar power (**such as at twilight, at night etc.**)) and against overload and overheating.
- Floating Operation:** Observation of the characteristic lines of charging, even with simultaneous operation of consumers being connected to the battery.
- Overcharge protection:** Reduction of the charging current of the battery in case of excessive solar power and full battery. Immediate recharging in case of power consumption to ensure always the best possible charging state of the battery.
- Characteristic Line of Charging "IU1oU2":** A defined charging boost (U1) avoids harmful acid accumulation and provides compensation charge to the individual battery cells. After that, automatic trickle charging (U2).
- On-board Mains Suppression Filter:** Integrated on-board mains suppression filter ensures unproblematic parallel operation of the controller with other charging sources, wind- and petrol-driven generators, mains supply chargers, dynamos etc. at one battery.
- Connection for Temperature Sensor:** Automatic adaptation of the charging voltage to the **battery temperature**. In **case of low outside temperatures, full charging** of the weaker battery **is improved**, and in case of summery temperatures **unnecessary battery gassing** will be avoided.

This is highly recommended, if the battery is exposed to strong variations in temperature, such as in the motor compartment.

- **Charging Cable Compensation:** Automatic compensation of voltage losses on the charging cables.
- **Measurement Output for EBL (Electroblock of the Vehicle):** Allows convenient application of the (solar) current display being installed in the electroblock for supervision of the solar system.
- **Terminal „AES“ (only SR 330 Duo Dig. and SR 530 Duo Dig.):**
Automatic commutation of ELECTROLUX / DOMETIC refrigerators with “AES” (Automatic Energy Selector) from gas operation to 12 V operation in case of excess solar power.
- **Ready for connection of the VOTRONIC Solar Displays** for optimum control of the system:
LCD Solar Computer S: The LCD display indicates the following values: Battery voltage, charging current, charging capacity, stored capacity and energy (V, A, W, Ah, Wh).



**Open acid batteries and batteries being „maintenance-free according to EN / DIN“:
Check the acid level periodically!**



**Recharge totally discharged batteries immediately!
Store only fully charged batteries and recharge them periodically!**



Safety Regulations and Appropriate Application:

The solar controller has been designed according to the valid safety regulations.

Appropriate application is restricted to:

1. **Charging of lead-gel, lead-AGM, lead-acid or LiFePO4-complete-batteries (with integrated BMS!) of the indicated nominal voltage and simultaneous supply of the consumers being connected to these batteries in fixed installed systems.**
 2. **Solar panels up to the maximum power rating (Wp) of the used solar controller.**
 3. **The indicated cable cross sections at the charging ports and at the panel input.**
 4. **With fuses of the indicated capacity near the battery to protect the cabling between battery and charging ports.**
 5. **Technically faultless condition.**
 6. **Installation in a well-ventilated room, protected from rain, humidity, dust, aggressive battery gas, as well as in an environment being free from condensation water.**
- **Never use the unit at locations where the risk of gas or dust explosion exists!**
 - Cables are always to be laid in such a way that damage is excluded. Observe to fasten them tightly.
 - **The connection cables have always to be led from below to the solar controller to ensure that penetrating humidity cannot reach the controller in case of failure, which will result in destruction of the controller.**
 - Never lay 12 V (24 V) cables and 230 V mains supply cables into the same cable conduit (empty conduit).
 - Check live cables or leads periodically for insulation faults, points of break or loosened connections. Occurring defects must be remedied immediately.
 - The unit is to be disconnected from any connection prior to execution of electrically welding or work on the electric system.
 - If the non-commercial end-user is not able to recognize the characteristic values being valid for a unit or the regulations to be observed, a specialist is always to be consulted.
 - The user/buyer is obliged to observe any construction and safety regulations.
 - **Except for the fuse, the unit is not equipped with parts, which can be replaced by the user.
Always use replacement car fuses of the indicated capacity!**
 - **Keep children away from the solar controller and the batteries.**
 - Observe the safety regulations of the battery manufacturer.
 - Deaerate the battery room. Protect the unit from aggressive battery gases.
 - Ensure **sufficient ventilation** of unit and panel!
 - Strictly observe the instructions of the manufacturer for installation of the solar panel.
 - Non-observance may result in injury or material damage.
 - The warranty period is 24 months from the purchase date (against presentation of the sales slip or invoice).
 - The guarantee will be void in case of any inappropriate utilisation of the unit, if it is used beyond the technical specification, in case of improper operation, **intrusion of water** or external intervention. We do not assume any liability for any damage resulting hereof. The liability exclusion is extended to any service being executed by third, which has not been ordered by us in writing. Service is to be effected exclusively by VOTRONIC D-36341Lauterbach.

Connection Plan:

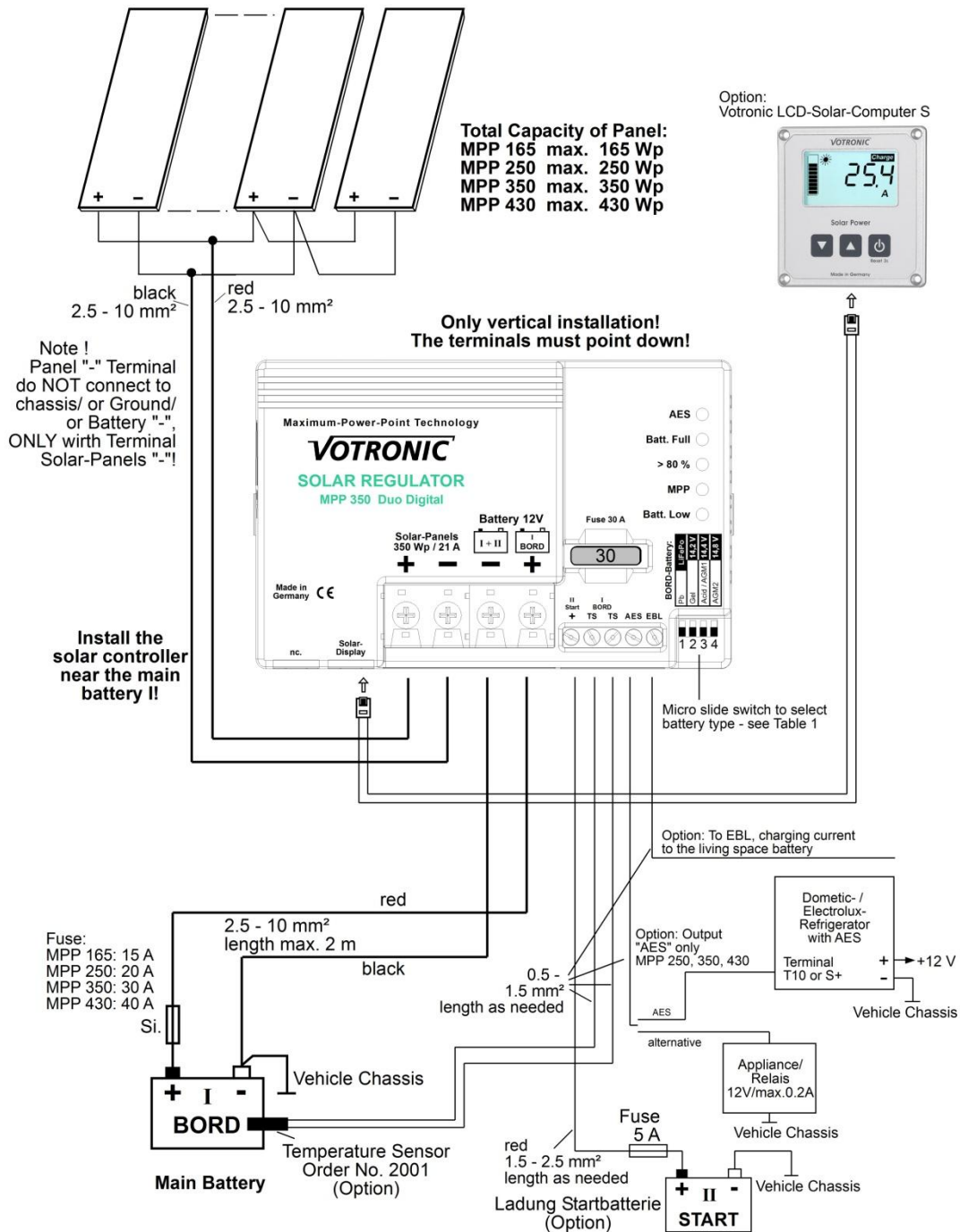

Note:

The connection plan shows the **maximum terminal assignment** for operation of all existing functions of the solar controller. The **minimum terminal assignment** consists of the solar panel inputs ("+" and "-") and the connections of the main battery.

Always connect the fuses as close as possible to the batteries (cable protection!).

Required Cable Cross Sections, Notes	SR 140 Duo Dig.	SR 220 Duo Dig.	SR 330 Duo Dig.	SR 530 Duo Dig.
+/- Panel cables, length as required	2.5-4 mm ²	4-6 mm ²	6-10 mm ²	10-16 mm ²
+/- Battery I cables, length max. 2 m	2.5-4 mm ²	4-6 mm ²	6-10 mm ²	10-16 mm ²
Fuse close to battery I	15 A	20 A	30 A	40 A



Cut-off Relay:

The cut-off relay, which exists in most of the vehicles, can, of course, still be used. (For charging by the dynamo, the cut-off relay connects the board battery to the starter battery during running motor of the vehicle. The cut-off relay is not included in the connection plan).

Mounting:

Screw-down the solar controller on an even and **hard mounting surface** at locations **being protected from humidity** and **near the main/board battery (BOARD I)** to ensure that the length of the battery's connection cable is **as short as possible**.

Vertical installation of the controller is highly recommendable (the **terminals** for solar panel and batteries **point down**).

This mode of installation improves cooling of the unit and **avoids that water runs along the connection cables** of the solar panel **into the solar controller**, even in case of damaged seals.

If used, the cable to the starter battery (START II) can be longer.

Despite the solar controller's high efficiency, heat is produced. Ensure sufficient **ventilation in the environment of the unit**, so that the heat can be carried-off.

The unit might heat-up. Consequently, the **vent holes** of the casing should never be covered to ensure full charging capacity (**minimum distance** all around: **10 cm**).

Connection (See Connection Plan):

The polarities (+ and -) of solar panel and batteries are absolutely to be observed!

Observe the cross-sections and length measures of the cables!



1. **Connection of the solar controller to the battery "Board I" should be effected first. Cable Protection: Insert the fuses near the batteries into the + cables (protection against cable fire)!**
2. **The solar panels should be protected from direct sunlight (by covering or shading) prior to connection.**

1.) Main/Board Battery „BOARD I“ (must be connected):

Connect the **battery connections** of the controller - (Minus) and + (Plus) to the 12 V main battery, observing the correct polarity and the cross section of the cables (**refer to connection plan**).

Never operate the controller without the battery „Board I“. If the battery is not connected, the unit will not deliver a defined output voltage.

In case of wrong polarity of battery I, the internal safety fuse will be released.

The replacement fuse should have the same capacity, and it should be of the same type (car fuse)!

Parallel charging of two or several batteries of the same voltage (12 V) is admissible. The batteries are to be „paralleled“, i. e. the „+“ connections of the batteries have to be coupled and should be connected to the „+“ connection of the solar controller. The minus (-) connections have to be coupled in the same way.

According to the battery manufacturers, **permanent** parallel operation is admissible in case of two or several batteries of the same voltage, type, capacity, as well as of the same age (history) in cross connection.

2.) Solar Panel (must be connected):

Shade the panels to minimize sparking during connection and to avoid damages due to eventual wrong polarity.

Observe the cable cross-sections (**refer to connection plan**)!

If several small solar panels are used, they are connected in parallel (refer to connection plan). Partial shading of the panels results in average higher capacity (**see connection plan**).

3.) Starter Battery „START II“ (Option, can be connected):

Connect the **second charging port** to the second battery using the red connection cable (**wire cross section 1.5 - 2.5 mm²**). This cable may be longer. In case of **non-utilization**, this terminal is **left free**.

If used, the output for starter battery II will be working with reduced voltage and charging current rates. Thus, the valuable solar power will be supplied to board/solar battery I being more suitable.

However, the vehicles starter battery II will be kept in a condition, that starting will always be possible, even in case of longer downtimes and during winter operation.



Connection of the negative pole „START II“ is not required, if the negative pole „BOARD I“ is connected to the vehicle body. Depending on the length of the cable, it may also be connected to the common negative connection of the solar controller or to the negative pole of „BOARD I“.

4.) Plug-type Connection „Solar Display“ (Option, can be connected):

6-pole tip jack for connection of the **VOTRONIC Solar Displays** being ready for connection for optimum control of the solar system:

LCD Solar Computer S: The LCD display indicates the following values: Battery voltage, charging current, charging capacity, stored capacity and energy (V, A, W, Ah, Wh). (Order No.: 1250)

5.) "EBL" Connection for Electroblock with Display Panel DT... / LT... (Option, can be connected):

A cable set for connection of the solar controller to the EBL is required. **Order No.: 2007** (It is not included in the standard delivery scope of the controller).

The solar controller supplies a signal at the terminal "EBL" for display of the solar charging current of board battery I (battery living area), which is suitable for electroblock EBL... with DT.../LT... Display Panel.

The signal cable being required for that, as well as a connection cable for connection of the solar controller to the EBL are included in the set of EBL connection cables.

6.) „AES“ (Automatic Energy Selector) only SR 330 Duo Dig. and SR 530 Duo Dig. (Option, can be connected):

The delivery scope of DOMETIC / ELECTROLUX includes refrigerators with all-automatic energy selection (230 V AC, 12 V DC or gas).

Particularly in summer, a lot of excess energy might be produced due to strong solar radiation, full batteries and low energy consumption, which is left unused. The solar controller recognizes this condition and uses the „AES“ output to give a signal to the refrigerator, which will commutate from gas operation to 12 V operation to benefit from the excess energy (gas saving).

Connection:

Lead a single-pole cable (0.5-1.5 mm²) from the solar controller's terminal „AES“ to the refrigerator's terminal „T10“.

Function:

The solar controller recognizes the excess capacity (LED „AES“ is lighting). The refrigerator switches from gas operation to 12 V operation. This mode will be kept for at least half an hour to avoid that the refrigerator will be "swinging" between 12 V operation and gas operation.

Should the solar power be still sufficient, the 12 V operation of the refrigerator will be kept.

Should the solar power be insufficient, „AES“ will be switched off by the solar controller, the refrigerator will be switched to gas operation, it will keep this mode for at least half an hour, and the solar power will be used for recharge of the (possibly slightly discharged) battery. This mode of operation can only be taken into account in case of sufficient efficiency of the solar panel and under favourable conditions, such as 110 Wp, better 150 Wp or more.

Option:

Optionally, small 12 V consumers can be operated at the AES output, such as 12 V fans, car relays or refrigerators with control input D+ (Thetford etc.). It must be observed, that the output must be active for at least half an hour.



The output current of the terminal "AES" is max. 200 mA. In case of larger consumers the output is limited and can again be loaded after a cooling down phase.

7.) Temperature Sensor, Input „T T“ (Option, can connected):

Connection for the external Votronic Temperature Sensor 825, order No. 2001 (is not included in the standard delivery scope).

For automatic adaptation and correction of the charging voltage to the battery temperature (temperature compensation).

Mounting:

The **thermal contact** of sensor and **battery "Board I"** (inside temperature) should be well. Thus, it should be screwed down to the negative pole or positive pole of the battery. It is also possible to fasten it at the sidewall centre of the battery casing. Ensure that the installation place is not influenced by any source of heat (motor block, exhaust, heater etc.).

Connection:

Connect the temperature sensor to the terminal by means of a 2-pole cable (cable cross section 0.5 - 1.5 mm²). The polarity and cable length is of no importance. **The solar controller recognizes the sensor automatically.**

Effect:

The temperature-dependent charging voltage of battery I will be adapted automatically to the battery temperature.

The temperature sensor measures the battery temperature. In case of low temperatures (winter operation), the charging voltage will be increased in order to improve and accelerate full charging of the weak battery. Sensitive consumers are protected by a limitation of the voltage in case of very low outside temperatures. In case of summery temperatures, the charging voltage is reduced to minimize the load (gassing) of the battery and to extend the lifetime of gas-tight batteries.

(See "Charging Voltage Rates and Temperature Compensation of Board Battery I" on page 10.

Safety Mode:

Battery Protection:

(also see characteristic lines: "Charging Voltage Rates and Temperature Compensation of Board Battery I):

In case of too low battery temperatures (-30 °C for lead batteries or -20 °C for LiFePO₄) or too high battery temperatures (from +50 °C), the charging voltage will be reduced strongly to **safety charging voltage** for battery protection (depending on the type from 12.75 V to 13.00 V). Safety mode, LED "charge" is flashing, but any charging data being recorded hitherto will be kept in memory.

Battery charging is then interrupted, but the supply of eventually connected consumers will be continued by the solar controller, and the battery can cool down. As soon as the battery temperature reaches the admissible range again, automatic charging will be continued.



The solar controller recognizes automatically a missing sensor, cable break or short-circuit of the sensor lines, as well as unreasonable measuring values. In that case, it will switch automatically to the usual charging voltage rates of 20 °C / 25 °C being recommended by the battery manufacturers.

Pilot Lamps:

„AES“ (excess power display, only SR 330 Duo Dig. and SR 530 Duo Dig. **green**):

- If it is lighting: Sufficient excess solar power, the output "AES" for automatic energy selection of the refrigerator or of a consumer is activated.
- Off: Output "AES" is switched-off.

“Batt. Full“ (Battery fully charged, **green**):

- If it is lighting: Battery (batteries) has (have) been charged to 100 %, trickle charge U2, finished.
- If it is lighting dimly: Main charging process is still effected in the charging phase U1.
- Off: Main charging process is still effected in the charging phase I.

„>80%“ (**green**):

- If it is lighting: Battery has been charged almost fully. Solar controller is still in the charging phase U1.

„Charge“ (**green**):

- If it is lighting: Brightness from slight dimly lighting up to full brightness indicates the charging current intensity.
- Off: Solar power is insufficient.
- If it is flashing: Safety mode battery protection: Battery temperature < -20/-30 °C or overtemperature +50 °C, Automatic return and continued charging in case of temperature drop of the battery by 2 °C.
- If it is flashing 1x: Disconnection of solar overvoltage: LED "Charge" is flashing 1 x. After that, the controller changes to stand-by. Imperatively check the voltage (Voc) of the solar module!

„Standby“ (only SR 140 Duo Dig. and SR 220 Duo Dig. **green**):

- If it is flashing: The controller is in stand-by mode, if solar current is not available (at night).

“Batt. Low“ (**yellow**):

- If it is lighting: Low voltage at main battery I. The battery should be recharged as soon as possible!

All light-emitting diodes **are flashing simultaneously**:

- The positions of the selector switches "BOARD Battery" are **incorrect**. For reasons of safety, the solar controller is switched-off. Adjust the desired battery type according to table 1.

Operating Instructions:

• Lifetime of the battery:

- **Recharge totally discharged batteries immediately!**
Sulphation of the lead battery plates due to total discharge is to be prevented by **soon charging**, particularly in case of high ambient temperatures. If the grade of sulphation is not too intensive, the battery can recover part of the battery capacity after **several charging/discharging cycles**.
- **Partially Discharged Batteries:**
In contrast to other battery types, batteries on lead basis **do not have any** harmful memory effect. Consequently: In case of doubt, partially discharged batteries have to be **charged fully** as soon as possible.
Always store only fully charged batteries. Recharge them periodically, particularly in case of used (older) batteries and higher temperatures.
- Keep batteries cool and dry; choose an appropriate location for installation.
- In case of **insufficient solar power** and/or high current consumption, the battery should be subject to occasional full charging by means of a mains supply charger.

• Overvoltage Protection:

The 12 V solar controllers protect themselves against connection of excessive battery voltage rates or will be switched-off in case of defective additional charging systems (chargers, generators or similar systems), switching threshold 15.0-16.0 V.

• Overvoltage Limitation:

Sensitive consumers are protected by means of a limitation of the charging voltage to max. 15.0 V during all modes of charging.

• Overload / Overheating Protection Solar Controller:

The solar controller is equipped with a double electronic protection against overload and with an automatic protection against adverse installation conditions (e. g. insufficient ventilation, excessive ambient temperatures) by gradual reduction of the charging capacity.

• Voltage Measurement:

Measurement of the voltage is to be effected at the battery and never at the solar controller (loss at the charging cable).

TIP

In case of unattended operation, the battery might be totally discharged due to too many consumers and lack of solar power. We recommend protecting the battery by means of the following appliances:

Votronic Battery Protector 40 (Power rating 12 V / 40 A) **Order No. 3075** or

Votronic Battery Protector 100 (Power Rating 12 V/ 120 A) **Order No. 3078**





Table 1: For Main Battery I: How to set the correct charging program for the battery type (design, lead or lithium-iron phosphate technology)





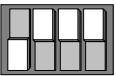

Prior to start-up, imperatively set the correct characteristic line of charging being suitable for the battery to avoid battery damages! Only use lithium iron-phosphate batteries in execution with integrated BMS (battery management system)!

Set the **slide switch ("Battery Type")** to the desired position for **battery I (board battery)** using a small screwdriver. Either select **Lead Battery** or **Lithium Iron-Phosphate Battery** using switch "1".

After that, select the desired characteristic line of charging using the switches „2“, „3“ and „4“, as indicated in the tables:

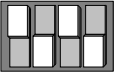
<p>Switch 1 "below"</p> <p>Lead Storage Battery</p>  <p>1 2 3 4</p>	<p>Charging programs for lead batteries:</p> <p>If not being specified divergently by the battery manufacturer, the suitable charging program for the battery type (design, technology) can be determined by means of the following description and the technical data (voltage rates U1 and U2, nominal temperature and dwell times U1).</p> <p>Note: The possible parallel/floating operation with consumers being connected to the battery is also automatically considered by all charging programs.</p>								
 <p>1 2 3 4</p>	<p>„Gel“: Charging program for gel/dryfit batteries:</p> <p>Adapted to closed, gas-tight Gel batteries with determined electrolytes, which are generally requiring a higher charging voltage level and longer dwell times U1 to achieve short charging times with particularly high capacity storage and to avoid total discharge, e. g. EXIDE, Sonnenschein dryfit-Start, Dryfit-Sport-Line, DETA Gel Battery Funline, Bosch AS Gel Batteries Va/Z, AS Gel Drive Batteries, AS Gel Lighting Batteries.</p> <p>If not being specified divergently by the battery manufacturer, also recommended for batteries in round cell technology, such as EXIDE MAXXIMA (DC).</p> <p>EXIDE, DETA, VARTA Characteristic Line Gel IU1oU2:</p> <table border="0"> <tr> <td>U1 = Main/Full Charging:</td> <td>14.30 V</td> <td>+20 °C</td> <td>3-10 h</td> </tr> <tr> <td>U2 = Full/Trickle/Storage Charging:</td> <td>13.80 V</td> <td>+20 °C</td> <td>Continuous</td> </tr> </table> <p>Safety mode at insufficient/excess temperature of the battery: 12.75 V -30 °C/+50 °C</p>	U1 = Main/Full Charging:	14.30 V	+20 °C	3-10 h	U2 = Full/Trickle/Storage Charging:	13.80 V	+20 °C	Continuous
U1 = Main/Full Charging:	14.30 V	+20 °C	3-10 h						
U2 = Full/Trickle/Storage Charging:	13.80 V	+20 °C	Continuous						
 <p>1 2 3 4</p>	<p>„Lead Acid/AGM1“: Charging program for acid/lead-acid batteries as well as AGM 14.4 V:</p> <p>For charging and trickle charge of supply (board) batteries. Ensures short charging times, high charging factor and acid mixing for open standard batteries and closed, low-maintenance, maintenance-free "non-solid electrolyte", "lead-acid", drive, lighting, solar and heavy duty batteries. Also suitable for recently developed batteries (low-antimonous, batteries with silver-alloy, calcium/calcium or similar) and batteries with low and very low water consumption, as well as AGM batteries with the indication 14.4 V.</p> <p>Characteristic line of charging IU1oU2 Acid/AGM:</p> <table border="0"> <tr> <td>U1 Main/Full Charging:</td> <td>14.40 V</td> <td>+20 °C</td> <td>1.5-6 h</td> </tr> <tr> <td>U2 Full/Trickle/Storage Charging:</td> <td>13.45 V</td> <td>+20 °C</td> <td>Continuous</td> </tr> </table> <p>Safety mode at insufficient/excess temperature of the battery: 12.80 V -30 °C/+50 °C</p>	U1 Main/Full Charging:	14.40 V	+20 °C	1.5-6 h	U2 Full/Trickle/Storage Charging:	13.45 V	+20 °C	Continuous
U1 Main/Full Charging:	14.40 V	+20 °C	1.5-6 h						
U2 Full/Trickle/Storage Charging:	13.45 V	+20 °C	Continuous						
 <p>1 2 3 4</p>	<p>„AGM2“: Charging Program for AGM/fleece Batteries 14.7 V:</p> <p>Adapted to closed, gas-tight AGM (absorbed glass mat) batteries and batteries in lead-fleece technology requiring a particularly high level U1 for full charging.</p> <p>ATTENTION: It is highly recommended to check the specification sheet of the battery concerning the high charging voltage U1 14.7 V.</p> <p>Unsuitable batteries might age prematurely due to loss of electrolyte!</p> <p>Some manufacturers of AGM / fleece batteries are also prescribing a 14.4 V charging program for charging! In these cases, please set "Lead Acid/AGM1 (14.4 V / 13.45 V).</p> <p>Characteristic Line AGM/Fleece IU1oU2:</p> <table border="0"> <tr> <td>U1 Main/Full Charging:</td> <td>14.70 V (!)</td> <td>+20 °C</td> <td>1.5-5 h</td> </tr> <tr> <td>U2 Full/Trickle/Storage Charging:</td> <td>13.50 V</td> <td>+20 °C</td> <td>Continuous</td> </tr> </table> <p>Safety mode at insufficient/excess temperature of the battery: 12.75 V -30 °C/+50 °C</p>	U1 Main/Full Charging:	14.70 V (!)	+20 °C	1.5-5 h	U2 Full/Trickle/Storage Charging:	13.50 V	+20 °C	Continuous
U1 Main/Full Charging:	14.70 V (!)	+20 °C	1.5-5 h						
U2 Full/Trickle/Storage Charging:	13.50 V	+20 °C	Continuous						
 <p>1 2 3 4</p>	<p>Not used. All LEDs are flashing, and the charging port is switched-off by the solar controller.</p>								

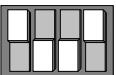
<p>Switch 1 "above"</p> <p>Lead Storage Battery LiFePO4</p>  <p>1 2 3 4</p>	<p>Charging programs for LiFePO4 batteries:</p> <p>If not being specified divergently by the battery manufacturer, the suitable charging program for the battery type can be determined by means of the following description and the technical data (voltage rates U1 and U2 and dwell times U1). Generally, lower charging voltage rates have a positive effect on the lifetime of the LiFePO4 battery.</p> <p>Attention: Only connect lithium iron-phosphate batteries with integrated BMS (battery management system)!</p> <p>Note: The possible parallel/floating operation with consumers being connected to the battery is also automatically considered by all charging programs.</p>												
 <p>1 2 3 4</p>	<p>„LiFePO4 14.2 V“: Characteristic line of charging lithium iron-phosphate with charging voltage 14.2 V.</p> <p>ATTENTION: Only connect LiFePO4 batteries with integrated BMS!</p> <p>Characteristic line LiFePO4 IU1oU2:</p> <table border="0"> <tr> <td>U1 Main/Full Charging:</td> <td>14.20 V</td> <td>+20 °C</td> <td>0.5-3 h</td> </tr> <tr> <td>U2 Full/Trickle/Storage Charging:</td> <td>13.50 V</td> <td>+20 °C</td> <td>Continuous</td> </tr> <tr> <td>Safety mode at insufficient/excess temperature of the battery:</td> <td>13.00 V</td> <td>-20 °C/+50 °C</td> <td></td> </tr> </table>	U1 Main/Full Charging:	14.20 V	+20 °C	0.5-3 h	U2 Full/Trickle/Storage Charging:	13.50 V	+20 °C	Continuous	Safety mode at insufficient/excess temperature of the battery:	13.00 V	-20 °C/+50 °C	
U1 Main/Full Charging:	14.20 V	+20 °C	0.5-3 h										
U2 Full/Trickle/Storage Charging:	13.50 V	+20 °C	Continuous										
Safety mode at insufficient/excess temperature of the battery:	13.00 V	-20 °C/+50 °C											
 <p>1 2 3 4</p>	<p>„LiFePO4 14.4 V“: Characteristic line of charging lithium iron-phosphate with charging voltage 14.4 V.</p> <p>ATTENTION: Only connect LiFePO4 batteries with integrated BMS!</p> <p>Characteristic line LiFePO4 IU1oU2:</p> <table border="0"> <tr> <td>U1 Main/Full Charging:</td> <td>14.40 V</td> <td>+20 °C</td> <td>0.5-3 h</td> </tr> <tr> <td>U2 Full/Trickle/Storage Charging:</td> <td>13.55 V</td> <td>+20 °C</td> <td>Continuous</td> </tr> <tr> <td>Safety mode at insufficient/excess temperature of the battery:</td> <td>13.00 V</td> <td>-20 °C/+50 °C</td> <td></td> </tr> </table>	U1 Main/Full Charging:	14.40 V	+20 °C	0.5-3 h	U2 Full/Trickle/Storage Charging:	13.55 V	+20 °C	Continuous	Safety mode at insufficient/excess temperature of the battery:	13.00 V	-20 °C/+50 °C	
U1 Main/Full Charging:	14.40 V	+20 °C	0.5-3 h										
U2 Full/Trickle/Storage Charging:	13.55 V	+20 °C	Continuous										
Safety mode at insufficient/excess temperature of the battery:	13.00 V	-20 °C/+50 °C											
 <p>1 2 3 4</p>	<p>„LiFePO4 14.6 V“: Characteristic line of charging lithium iron-phosphate with charging voltage 14.6 V.</p> <p>ATTENTION: Only connect LiFePO4 batteries with integrated BMS!</p> <p>Characteristic line LiFePO4 IU1oU2:</p> <table border="0"> <tr> <td>U1 Main/Full Charging:</td> <td>14.60 V</td> <td>+20 °C</td> <td>0.5-3 h</td> </tr> <tr> <td>U2 Full/Trickle/Storage Charging:</td> <td>13.60 V</td> <td>+20 °C</td> <td>Continuous</td> </tr> <tr> <td>Safety mode at insufficient/excess temperature of the battery:</td> <td>13.00 V</td> <td>-20 °C/+50 °C</td> <td></td> </tr> </table>	U1 Main/Full Charging:	14.60 V	+20 °C	0.5-3 h	U2 Full/Trickle/Storage Charging:	13.60 V	+20 °C	Continuous	Safety mode at insufficient/excess temperature of the battery:	13.00 V	-20 °C/+50 °C	
U1 Main/Full Charging:	14.60 V	+20 °C	0.5-3 h										
U2 Full/Trickle/Storage Charging:	13.60 V	+20 °C	Continuous										
Safety mode at insufficient/excess temperature of the battery:	13.00 V	-20 °C/+50 °C											
 <p>1 2 3 4</p>	<p>„LiFePO4 14.7 V“: Characteristic line of charging lithium iron-phosphate with charging voltage 14.7 V.</p> <p>ATTENTION: Only connect LiFePO4 batteries with integrated BMS!</p> <p>Characteristic line LiFePO4 IU1oU2:</p> <table border="0"> <tr> <td>U1 Main/Full Charging:</td> <td>14.70 V</td> <td>+20 °C</td> <td>0.5-3 h</td> </tr> <tr> <td>U2 Full/Trickle/Storage Charging:</td> <td>13.70 V</td> <td>+20 °C</td> <td>Continuous</td> </tr> <tr> <td>Safety mode at insufficient/excess temperature of the battery:</td> <td>13.00 V</td> <td>-20 °C/+50 °C</td> <td></td> </tr> </table>	U1 Main/Full Charging:	14.70 V	+20 °C	0.5-3 h	U2 Full/Trickle/Storage Charging:	13.70 V	+20 °C	Continuous	Safety mode at insufficient/excess temperature of the battery:	13.00 V	-20 °C/+50 °C	
U1 Main/Full Charging:	14.70 V	+20 °C	0.5-3 h										
U2 Full/Trickle/Storage Charging:	13.70 V	+20 °C	Continuous										
Safety mode at insufficient/excess temperature of the battery:	13.00 V	-20 °C/+50 °C											
 <p>1 2 3 4</p>	<p>„LiFePO4 14.8 V“: Characteristic line of charging lithium iron-phosphate with charging voltage 14.8 V.</p> <p>ATTENTION: Only connect LiFePO4 batteries with integrated BMS!</p> <p>Characteristic line LiFePO4 IU1oU2:</p> <table border="0"> <tr> <td>U1 Main/Full Charging:</td> <td>14.80 V</td> <td>+20 °C</td> <td>0.5-3 h</td> </tr> <tr> <td>U2 Full/Trickle/Storage Charging:</td> <td>13.70 V</td> <td>+20 °C</td> <td>Continuous</td> </tr> <tr> <td>Safety mode at insufficient/excess temperature of the battery:</td> <td>13.00 V</td> <td>-20 °C/+50 °C</td> <td></td> </tr> </table>	U1 Main/Full Charging:	14.80 V	+20 °C	0.5-3 h	U2 Full/Trickle/Storage Charging:	13.70 V	+20 °C	Continuous	Safety mode at insufficient/excess temperature of the battery:	13.00 V	-20 °C/+50 °C	
U1 Main/Full Charging:	14.80 V	+20 °C	0.5-3 h										
U2 Full/Trickle/Storage Charging:	13.70 V	+20 °C	Continuous										
Safety mode at insufficient/excess temperature of the battery:	13.00 V	-20 °C/+50 °C											

Now, the solar controller is ready for operation.

Switch "Functions":

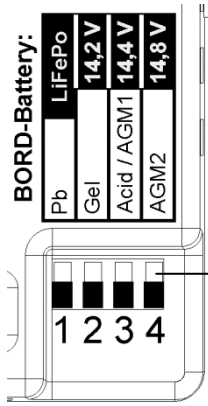

Switch 1:

Selection of either lead (Pb) or lithium iron-phosphate batteries

Switches 2, 3 and 4:

Selection of the characteristic lines of charging for lead (switch 1, below), or lithium iron-phosphate (switch 1, above)

The corresponding characteristic lines of charging can be drawn from table 1!

White Lever

Further actions of the unit are not required.

Charging Voltage Rates and Temperature Compensation of Board Battery I:

Lead Batteries:

Charging Program "Lead Acid/AGM1", Characteristic Line IU1oU2

Charging Program "AGM2", Characteristic Line IU1oU2

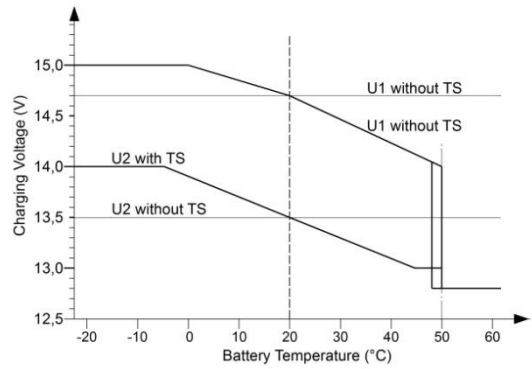
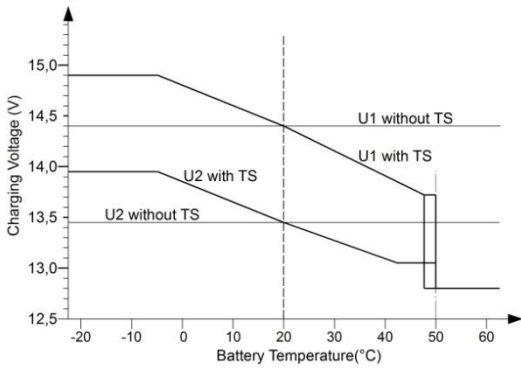

Charging Program „Gel“, Characteristic Line IU1oU2

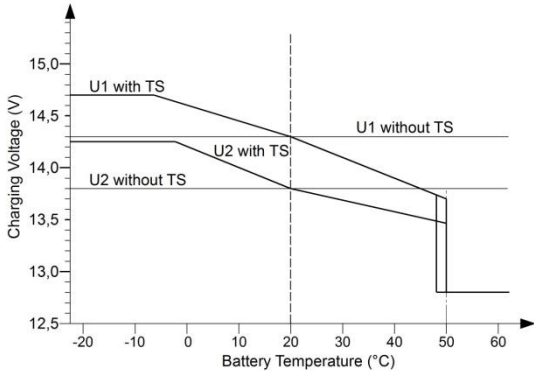

TS = If a temperature sensor is used

LiFePO4 Batteries:

Characteristic Line LiFePO4 IU1oU2.

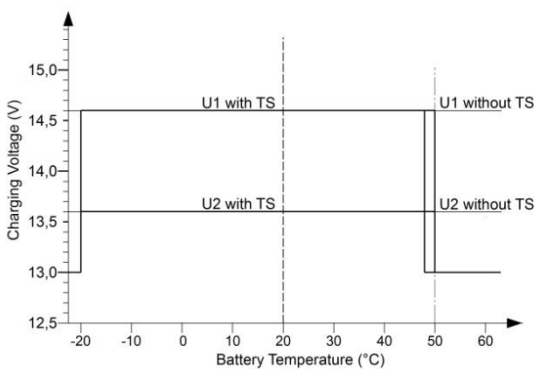

The corresponding voltage rates U1 and U2 of the characteristic lines LiFePO4 can be drawn from table 1!

(Representation: Characteristic Line LiFePO4 14.6 V)

Functions (at the Main / Board Battery „Board I“):

If **solar power is missing** (at night), readiness for service of the controller will be indicated by short **flashing** of the LED (light-emitting diode) "**Charge**".

SR 140 Duo Dig. and 220 Duo Dig.: In any operating state, a **totally discharged battery** is indicated by means of the LED "**Batt. Low**" (low voltage). Now the battery has to be recharged as soon as possible (disconnect the consumers)!

SR 330 Duo Dig. and 530 Duo Dig.: The LED "**AES**" will be lighting in case of excess solar power, output "**AES**" is active.

An evenly flashing LED "**Charge**" indicates a possible failure in the system: Controller overheated or failure found during self-test, battery too hot (>50 °C) when using the battery temperature sensor.

As soon as the **solar power** is again **sufficient**, the LED "**Charge**" will be lighting and the charging process starts.

At the same time, the **brightness of the LED "Charge"** is a measure for the **converted solar power**: The brighter, the more of the existing (also little) solar power will be supplied.

1. Maximum charging current (**Phase I**) in the lower and mean voltage range of the battery up to the beginning of the phase U1. The total solar power will be supplied to the battery for quick charging. During the phase I, charging will be effected up to approx. 75 to 80 % charging state.
2. During the following **phase U1** the battery voltage will be kept constant on a high level close to the gassing limit, the battery determines the charging current according to its charging state, the high battery capacity will be charged and the LED "**>80%**" is lighting.
The solar controller will control the charging time as well as the charging voltage and will switch automatically to the following phase U2=trickle charge. If the battery has already been charged fully, the charging time will be reduced accordingly.
3. During the **phase U2** (Full charging/trickle charge) the battery will be kept on its charging level. Only the compensating recharging current is flowing being required for conservation of the full charge, which is determined by the battery. The duration of that phase is not limited, the LED „**Batt. Full**“ is lighting intensively.

Now, almost the entire solar current is available to the consumers.

Switching back to the phase I or U1 is effected, if the battery had been subject to load for an extended period, or if the solar controller switches to stand-by mode after sunset.

If a temperature sensor is used for the battery, the voltage values will be slightly higher in case of low outside temperatures, while they will be slightly lower in case of high outside temperatures.

The output for the „Battery II“ (START) will be working with reduced voltage and charging current rates. Thus, the valuable solar power will be supplied to board/solar battery „I“ being more suitable. However, the starter battery „II“ will be kept in a condition, that starting will always be possible, even in case of longer stop periods (e. g. in winter).

Charging Process (Characteristic Line of Charging IU1oU2) at the Board Battery "Board 1" in Case of Sufficient Solar Power:

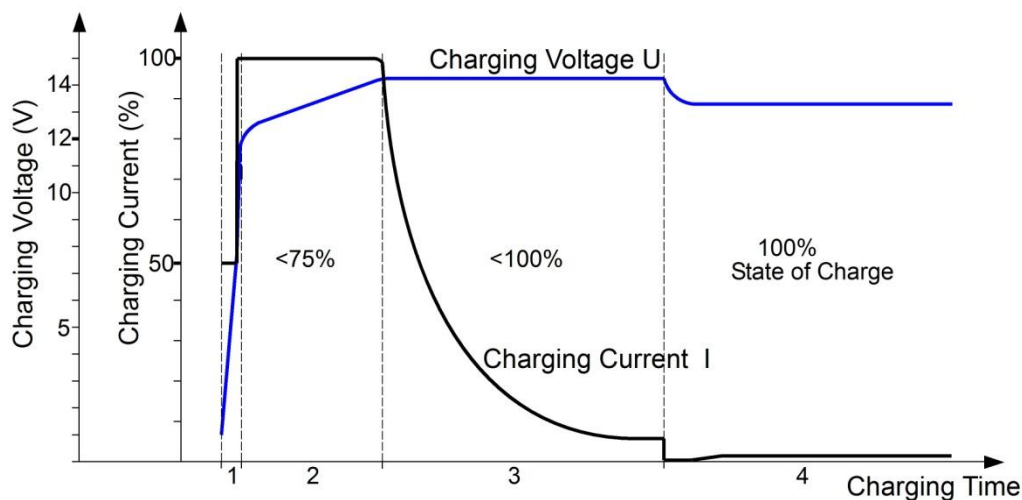

1. **Preliminary** charging of totally discharged battery, gentle initial charging current (I-Phase)
2. **Main charging** constant, maximum charging current (I-Phase)
3. **Main/full charging** constant charging voltage 1 (U1-Phase)
4. **Full/Trickle charge** constant continuous charging voltage 2 (Phase U2)

Technical Data:	SR 140 Duo Digital	SR 220 Duo Digital	SR 330 Duo Digital	SR 530 Duo Digital
Capacity of Solar Module (recommended / max.):	50 - 140 Wp	50 - 220 Wp	50 - 330 Wp	50 - 530 Wp
Current Solar Module:	0 - 9.0 A	0 - 14.0 A	0 - 21.0 A	0 - 33.0 A
Voltage Solar Module (Voc):	max. 28 V	max. 28 V	max. 28 V	max. 28 V
Nominal Voltages of Batteries Board I and Start II:	12 V	12 V	12 V	12 V
Charging Current:	0 - 9.0 A	0 - 14.0 A	0 - 21.0 A	0 - 33.0 A
Current Consumption Stand-by (max.):	4 mA	4 mA	4 mA	4 mA
Main Port Battery I (BOARD I):				
Charging/Floating/Load Current:	0 - 9.0 A	0 - 14.0 A	0 - 21.0 A	0 - 33.0 A
Max. Prelim. Charg. Current (totally discharged battery):	4.5 A (<8V)	7.0 A (<8V)	10.5 A (<8V)	16.5 A (<8V)
Reset Voltage (30 sec):	12.7 V	12.7 V	12.7 V	12.7 V
Charging Programs for Gel/AGM/Acid/LiFePO4 Batteries:	8	8	8	8
Charging Voltage Limitation (max.):	15.0 V	15.0 V	15.0 V	15.0 V
Integrated Overload Protection (Current Limiting Device):	Yes	Yes	Yes	Yes
Integrated Protection against Short-circuit:	Yes	Yes	Yes	Yes
Integrated Protection against Overtemperature:	Yes	Yes	Yes	Yes
Integrated Cooling Fan with Temp. Control:	-	-	Yes	Yes
Unit Fuse (Type FKS):	15 A	20 A	30 A	40 A
Input for Battery I Temperature Sensor:	Yes	Yes	Yes	Yes
Charging Timer:	3-fold	3-fold	4-fold	4-fold
Refrigerator Control Output "AES":	-	-	Yes	Yes
Switching Current Control Output "AES" max.:	--	--	12 V/0.2 A	12 V/0.2 A
Signal Output "EBL" for Display				
"Solar" Charging Current Battery Living Area:	Yes	Yes	Yes	Yes
Auxiliary Port Vehicle Starter Battery II (Start II):				
Charging Current:	0 - 0.8 A	0 - 0.8 A	0 - 1.5 A	0 - 1.5 A
Integrated Overload Protection (Current limiting device):	Yes	Yes	Yes	Yes
Integrated Protection against Short-circuit:	Yes	Yes	Yes	Yes
Integrated Protection against Overtemperature:	Yes	Yes	Yes	Yes
Dimensions, incl. Mounting Flanges (mm):	131 x 77 x 40	131 x 77 x 40	131 x 77 x 40	131 x 77 x 40
Weight:	150 g	155 g	165 g	170 g
Ambient Conditions, Humidity of Air:	-20°C ... +45 °C max. 95 % RH, no condensation			



Disposal of the product in the normal household waste is not allowed.



with the directives for Reduction of Hazardous Substances in Electrical and Electronic Equipment.

The product conforms to RoHS. Thus, it complies

Quality Management System

DIN EN ISO 9001

E1 10 R- 04 7602



Declaration of Conformity:

According to the stipulations of the regulations 2006/95/EG, 2004/108/EG, 2009/19/EG this product corresponds to the following standards or standardized documents: EN55014; EN55022 B; DIN14685; DIN40839-1; EN61000-4-2; EN61000-4-3; EN 61000-4-4.

Delivery Scope:	Available Accessories:	
• Solar Controller	• Temperature Sensor 825	Order No. 2001
• Operating Manual	• LCD Solar Computer S	Order No. 1250
	• Cable set for connection of the solar controller to the EBL	Order No. 2007

Subject to misprints, errors and technical modification without notice.

All rights reserved, particularly the right of reproduction. Copyright VOTRONIC 03/17.

Made in Germany by VOTRONIC Electronic-Systeme GmbH & Co. KG, Johann-Friedrich-Diehm-Str. 10, 36341 Lauterbach/GERMANY

Phone: +49 (0)6641/91173-0 Fax: +49 (0)6641/91173-20 E-Mail: info@votronic.de Internet: www.votronic.de